

## Intraoral Scanner

Operation Manual  
Technical Manual



### Ningbo Runyes Medical Instrument Co., Ltd.

Add: 032 Building, No. 456, Tonghui Road, Jiangbei Investment  
& Pioneering Park C, 315033, Ningbo, China

Telephone: 0574-27709922  
E-mail: runyes@runyes.com

Fax: 0574-27709923  
Http://en.runyes.com

Version Number: 2023-04-12

## Content

- Chapter 1: Introduction P1-P5
  - Components
  - Intended use
  - Features
  - Power
  - Product life
  - Contraindication
  - Classification
  - Specification
  - Components of scanner
  - Label
  - Port and button
- Chapter 2: Hardware Installation P6-P8
  - Components
  - Installation notes
  - Specification
  - Cable connection
- Chapter 3: Software Installation P9-P20
  - Install software
  - The image acquisition process of runyes 3ds scanner
  - Running Runyes 3DS scanner
- Chapter 4: Maintenance P21-P28
  - Maintain scanner
  - Disinfection
  - Q&A
  - Product application precautions
  - Circuit connection chart
  - Technical specification
  - Waste disposal
  - Electromagnetic compatibility
- Chapter 5: Accessories P29-P32

## Introduction

Thank you for your trust in us. We hope this product will satisfy you completely. It is recommended that you read this manual before installation and use, which is beneficial to eliminate and reduce the risk to you and your patients due to misoperation. It is used for oral digital printing.

### ◆ Components

Scanner host, Base, Scanner tip, Data cable, USB cable connector, Power Adaptor, Dongle and U Disk with Software.

### ◆ Intended use

Using optical scanning method to collect the 3D geometric data of the tooth in the patient's mouth and provide the 3D digital model for CAD/CAM denture design and processing.

### ◆ Features

The excellent image quality is based on advanced CMOS technology. The more convenient three-country collection process is more compact and comfortable, durable scanning tip • easy to use USB 2.0 interface.

### ◆ Power

Power Adaptor  
 Input: 100-240V~ | 50-60Hz | 0.5A  
 Output: 12V --- 1.5A  
 Intraoral scanner: 12V --- 1.5A

### ◆ Product life

8 years

### ◆ Contraindication

No

### ◆ Classification

GB 9706.1-2007 first part of medical electrical equipment: safety general requirements GB 191-2008 packaging and shipping diagram mark this product safety classification belongs to type II BF medical device equipment.

This device does not belong to the operation mode of AP type or APG type device. Operation mode of the device: continuous operation. Anti-infection level: IPX0.

### ◆ Specification

According to the oral cavity digital printer area different classification

Model	Scope of reconstruction	Pixel
IOS-11	14 x 14 x 15 mm	1024 X 768 pixels

### ◆ Components of scanner

No.	Components	Quantity
1	Scanner Handpiece (with protective tip)	1
2	Scanner tip	4
3	Base	1
4	Data cable	1
5	USB cable connector	1
6	Power adaptor(12V)	1
7	Dongle	1
8	U disk with software	1
9	Operation Manual	1

Please check the above table to see if the parts are complete before the installation of the Runyes 3DS Intraoral Scanner. If some components do not match, you cannot install them. Please contact the local distributor or agent for support if you can't install the system.

#### Scanner:

The scanner's 3D information is reconstructed from 2D images taken by the scanner. The scanner is mainly composed of optical and imaging systems, and the top of the handpiece has protective glass protection.

#### Scanner tip:

Made of medical non-pound steel and optical prism, it is installed into the head of the scanner for scanning. The scanning head can be sterilized in accordance with the prescribed method.



#### Base:

Hold the handpiece, after putting the handpiece on the base, the scanner will be at standby mode.

#### Connector box:

Connection between the handpiece and computer, mainly for the transition of the data signals.



#### Data cable:

Used to transmit the output signal from the Scanner

USB cable: It is used to transmit output signals from the base to the computer, connecting the base and the computer.

Power adapter: 12V= 1.25A medical certification power adapter.

◆ Label



II type equipment



B type application part



Important info  
Please refer to this manual



Power



NOTE

Represents useful information and how to use our software



CAUTION

Express important instructions.  
Failure or damage system or other property if not observed.



WARNING

Represents warnings and safety instructions.  
Failure to comply may be a serious threat and injury to the patient and operator.

◆ Port and button

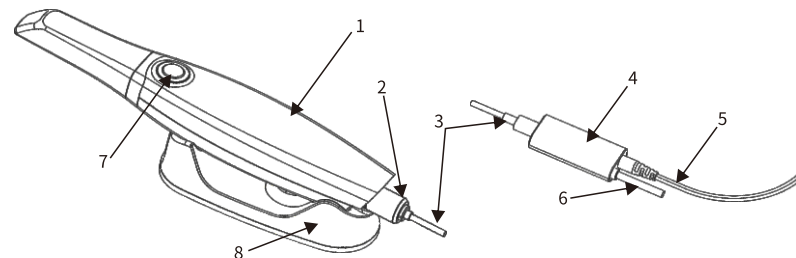

1. Part 3, Type C cable is connected to handpiece, and tightly screw the part ; .

Note: Please plug in the cable connection at first, and then tighten the screw. please pay attention to the snap direction(Figure 1);

2. The other port of the part 3 is connected to the part 4, connector box.

3. The USB port of the connector box is to connected to the computer;

4. The other port of the connector is connected to the power adaptor;

5. After all connection, the light on handpiece is stable in blue , it means the scanner is ready;

6. Press the light button on the handpiece, the light on handpiece becomes green, it means the scanner starts scanning;

7. After finishing scanning, please place the handpiece on the base, and the handpiece will be at standby mode and stop scanning automatically.

8. Plug out the adaptor to disconnect the power supply if not using the scanner.

Note:

1. Before starting scanning, please kindly put on the scanner tip correctly, Please parallelly insert or remove the scanner tip based on Figure 2, without tilting;

2. Indicating light:

Green light: The scanner was preparing/scanning;

Blue light: Standby/ Ready to scan;

Flashing blue light:: Connection failed;

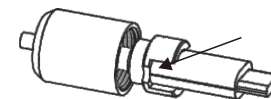

Figure 1

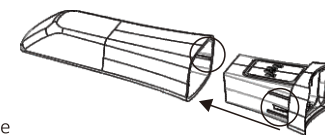

Figure 2

## Hardware Installation

### ◆ Components

You need to install the driver in the PC which to identify the 3DS scanner.

### ◆ Installation notes

1. When installing, please handle with care and minimize the distortion and pull of the wires. Do not thread or roll the wires.
2. Place the base in a suitable position to prevent falling.
3. Do not drop the handpiece and base on the ground so as not to cause irreparable damage.
4. In order to avoid disturbing images, don't let the system approach the strong magnetic field and avoid the static emission source.
5. Although the electromagnetic interference of this product is low, it does not guarantee that the operation does not affect the surrounding equipment. If there is interference, please keep the product away from the interference device.

### ◆ Specification



We cannot guarantee the work of the Runyes 3DS scanner and the pirated Microsoft Windows. So please use the legitimate version of Microsoft Windows 10.

#### PC Specification

- OS: Microsoft Windows 10 64 pro edition or above;
- CPU: Intel i7-8700 or above (Laptop i7-8750H or above);
- Video card and video memory: NVIDIA GeForce 1660GT or above graphics card, more than 6G;
- Memory: 16G or higher;
- Hard disk: 256G solid state hard disk or 128G solid state hard disk + 1T mechanical hard disk;
- Display resolution: 1920x1080;
- Operating system: WINDOWS 10 professional/enterprise edition;
- USB port: USB 3.0



Before installing the software and the server, you must close the Windows system's firewall and the anti-virus software with firewall function to make sure the software can be installed and run properly.

### ◆ Cable connection

1. Connect the handpiece to connector;



2. Plug USB cable to PC's USB port

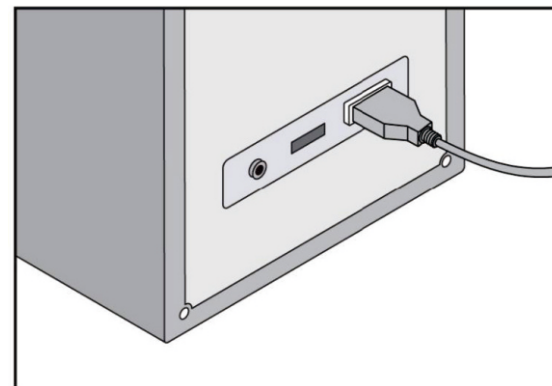

3.Connect the power adaptor to the connector



## Software Installation

### ◆ Install software

Step 1:

Insert U disc to the computer, manually operate installation

The file currently contained on the disc

 `setup_x64_2.1.23.0328_runyes_plus_globa...`

Step 2:

please select a language

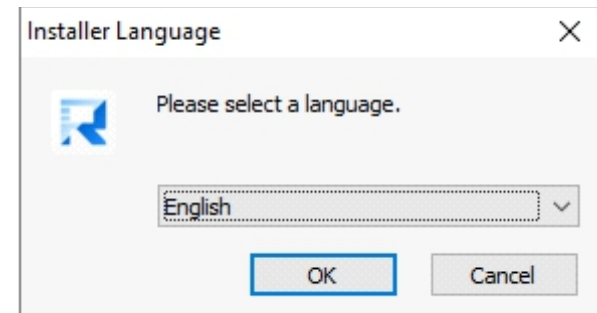

Step 3:  
Enter the installation wizard, click "Next".



Step 4:  
Read carefully the license terms before installation, if you agree with the agreement, please click "I Agree", if not click "Cancel"

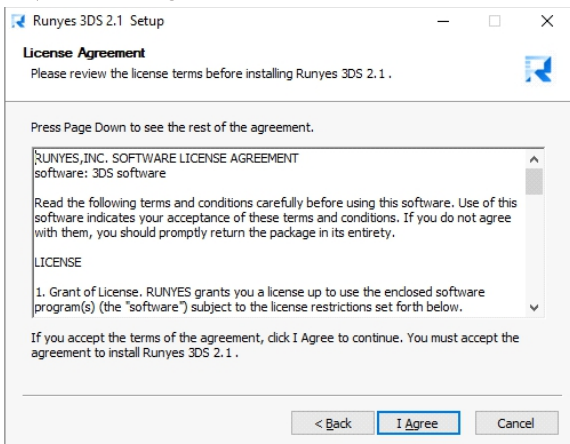

Step 5:  
When "Dental Viewer"'s installshield pops up, click"Next"

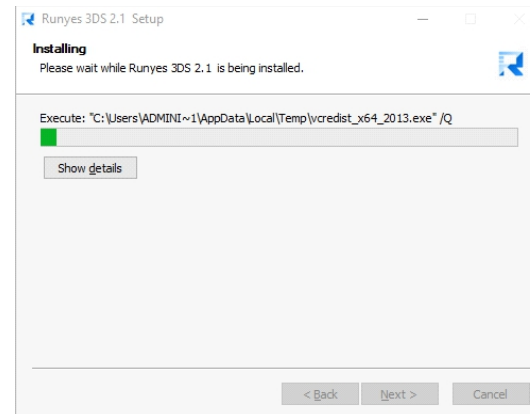

Step 6:  
Installation process, click" Finish" when it is finished.

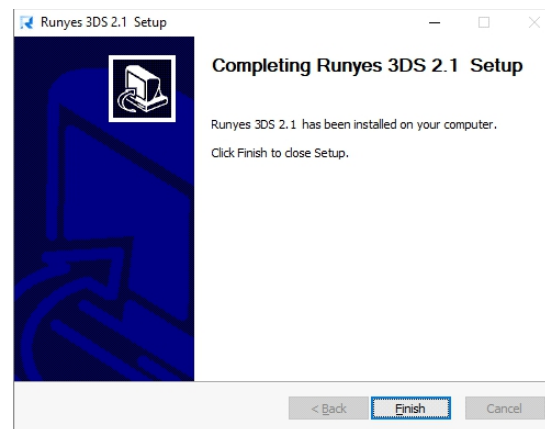

**Ready to Start Scanning:**

1. Make sure all the connections be ready
2. Enter the patient information, enter the scanning interface, and select the dental arch to be scanned.
3. Take the handpiece from the base, press the button, when the light becomes green means it is ready to start scanning.

**Scanner head:**

Caution: The scanner tip should be cleaned and disinfected after each use. Please follow the instructions of cleaning and disinfection to avoid cross-infection between patients.

**There are four consecutive steps of images capturing:**

1. Occlusal surface
2. Buccal side
3. Lingual Side
4. Mesial Side

**Occlusal surface scanning**

**⚠ Important:** The distance between the scanning window of the scanner tip and the surface to be measured is required. The distance must be kept between 0 and 15mm (best distance: 5mm). The scanning tip should not be on the teeth or gums. If the distance is too long, data cannot be collected.

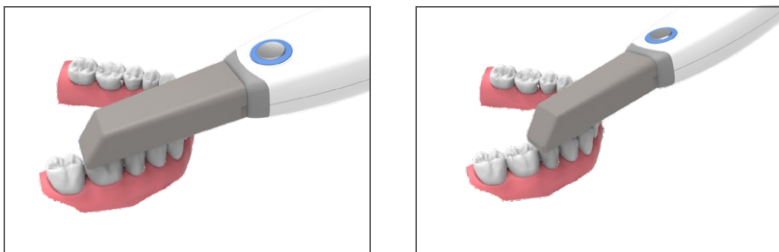

**Buccal side scanning**

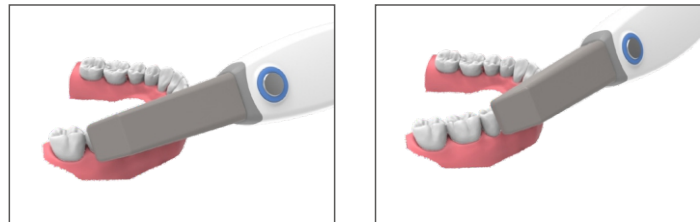

The scanning tip is located near the adjacent tooth of the prepared tooth.

1. Turn the scanning tip to the buccal side from 45 degrees to 90 degrees.(max degree)
2. Move the scanning tip over the surface of the tooth, through the entire buccal side.

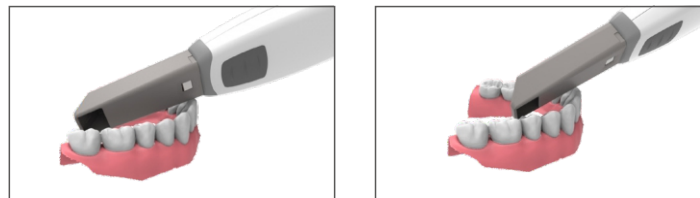

**Lingual side scanning**

The scanning tip is located near the adjacent tooth of the prepared tooth.

3. Rotate the scanner tip from 90 degrees on the buccal to the side of the lingual 45 degrees to the maximum 90 degrees.
4. Move the scanning tip over the surface of the teeth, through the entire lingual side.

**Mesial side scanning**

Move the scanning tip towards the direction of Mesial side by tilting the scanning tip, in order to take the good image of adjacent teeth.

**Reminder:**

Please remove the soft tissue.

Remove the active gums so that the gums are 1 to 2 mm away from the teeth. The next button is completed, and the calculation stage is optimized. After the optimization calculation, the final generated 3d image will be displayed. Please check the correct output. If part of the image is missing, click Scan and continue scanning.



◆ Running Runyes 3DS scanner

Intraoral scanning software operation process:

Step 1

Open the shortcut of "Runyes 3DS" on the desktop to enter the software interface



Step 2

Click the "New Patient" icon in the red box

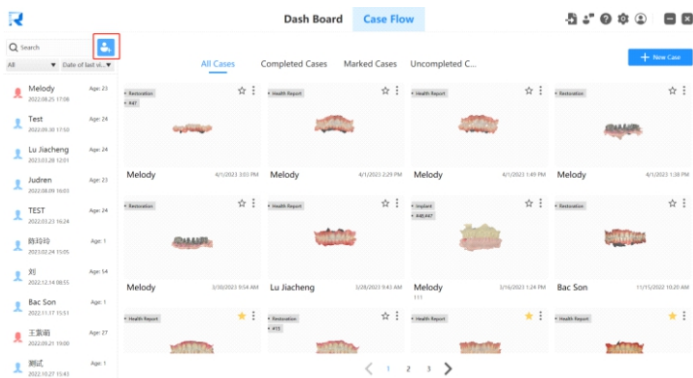

Step 3

Enter the "patient name" and other relevant information, click Add

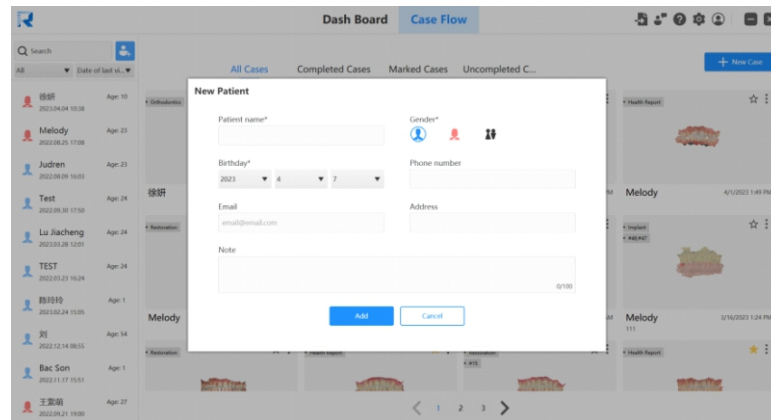

Step 4

Click the "New Case" icon in the red box

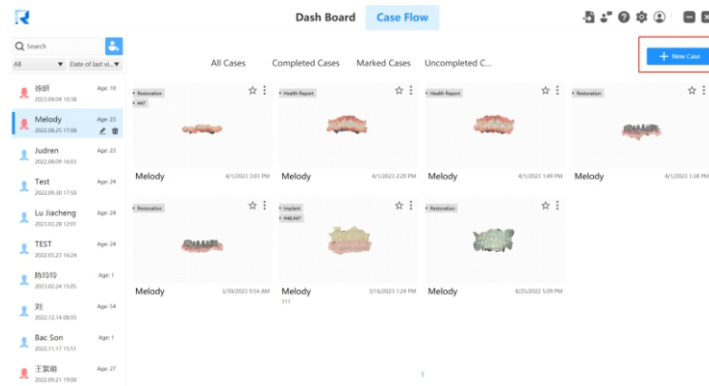

**Step 5**  
Click the "Next step"

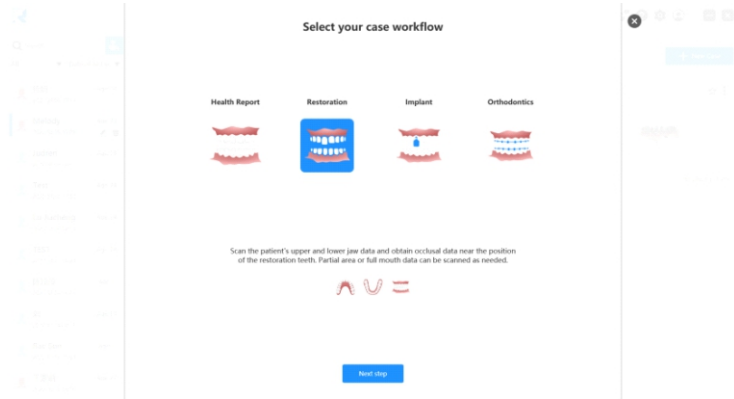

**Step 6**  
Click "Scan" in the lower right corner

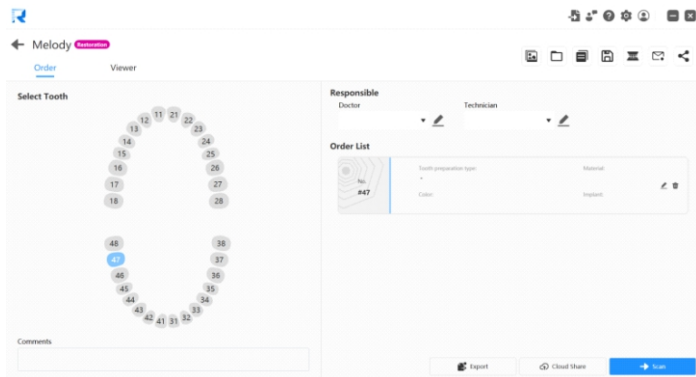

**Step 7**  
The main function of the main interface



1. System time and software version information
2. Process steps
3. Patient name
4. Scan object switching
5. 3D scan results show
6. Function key area: including "True Color", "Lock the Scanning View", "AI Scan", "Metal Scan", "Eraser", "Cut", "Lock Scan Area", "Delete", "Preview", "Reset View", "HD Camera"
7. Scanner Status/Video

**Step 8:**

Switch the scan object to "upper jaw" and scan to obtain a 3D model of the patient's upper jaw.

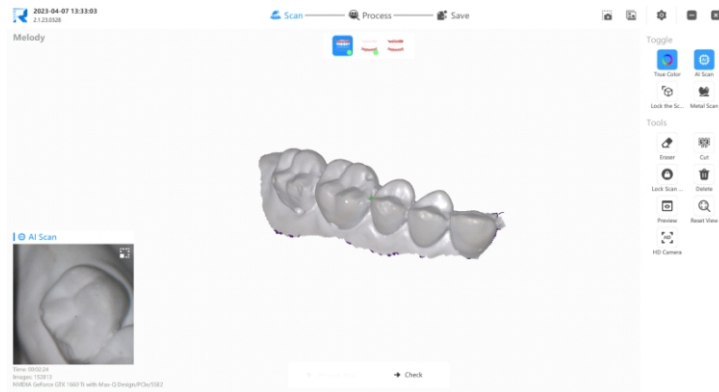

**Step 9:**

Switch the scan object to "lower jaw" and scan to obtain a 3D model of the patient's lower jaw.



**Step 10:**

Switch the scan object to "occlusion", and ask the patient to bite up and down in a normal state. Scan the teeth and move the scanner tip up and down to scan part of the upper and lower teeth, and then the software will automatically occlude the upper and lower teeth.

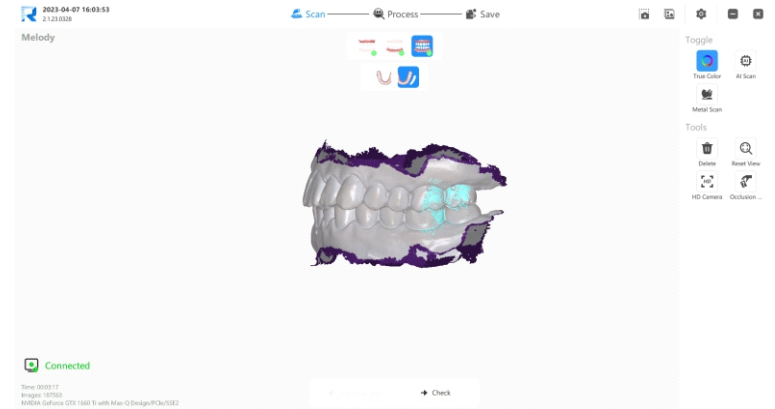

**Step 11:**

Click "Check" to check whether there is any problem in the final 3D model and whether it meets the design requirements, etc.



**Step 13:**

Click "Export", select the required file type, then click "OK", you can find the file under the corresponding path.

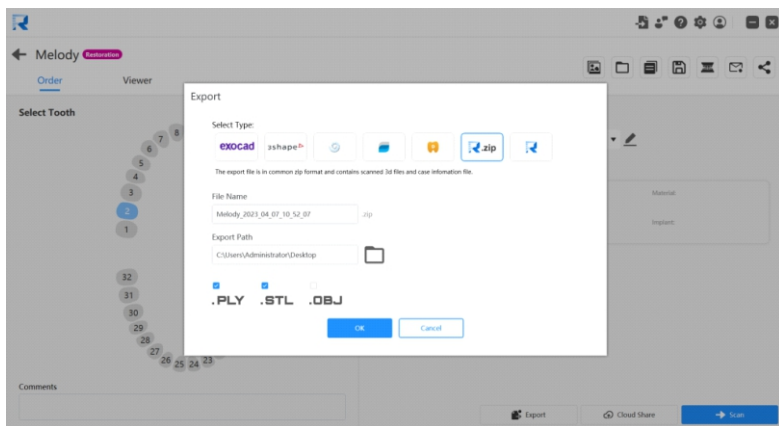

## Maintenance

### Visual Inspection

Like all electrical equipment, not only does the scanner need to be used correctly, it also needs to be inspected regularly. These measures will help ensure that the system operates accurately, safely and efficiently.

Before use, the operator should check for damage to the body or any system problems. If it is detected that it is different from the usual use, please further explain the problem of the product to the local dealer.

## ◆ Cleaning, Sterilization & Disinfection

### 1. Scanner Tip

**Cleaning:** Separate the scanning tip and the scanner handpiece, first clean the scanning tip and the lens with clean water (running water) and alcohol (75% concentration of medical alcohol), pay attention to remove the dirt, oil stains, spots and other traces on the lens. And dry the scanning tip and lens with a soft cloth (non-woven fabric) and a clean cotton swab, and handle well with drying.

### High Temperature & Pressure Sterilization:

Put the scanner tip in a special sterilization bag and seal it, and arrange the high-pressure steam sterilization in the following two ways:

- a. Select sterilization under 134°C for more than 3.5 minutes;
- b. Select sterilization under 121°C for more than 15 minutes;

After sterilization, it needs to be stored according to the infection control requirements. Before use, it is necessary to check whether the scanning head and the lens are in good condition. Those tips that need to be used immediately after sterilization should be taken out and allowed to stand for more than 30 minutes and cooled to room temperature before installation and operation.

**Note:** The scanning head is a consumable item and can be sterilized about 100 times in a high temperature sterilization environment. If the scanning head shell is broken, the contact reed falls off, the lens has cracks, serious spots and dirt that cannot be cleaned, etc. , the scanner tips need to be disposed of.

### Immersion Disinfection:

Immerse the scanner head in CIDEXOPA solution (0.55% o-phthalaldehyde) for more than 5 minutes. After completion, dry the scan head and the lens with a soft cloth (non-woven fabric) and a dust-free cotton swab, and use it immediately to avoid secondary pollution of the scanner tip. It is required to check whether the scanner head and the lens are in good condition before starting use.

Note: During immersion disinfection, the scanner head needs to be placed vertically in the disinfectant solution, and it must be dried after being taken out.

Note: The scanner head needs to be sterilized or disinfected when it is used for the first time, and it also needs to be sterilized or disinfected when it is used on different patients.

## 2. Scanner Handpiece

### 2.1. Scanner Handpiece Disinfection & Cleaning

Wipe the product cover with a normal cotton cloth dipped in a small amount of soapy water. Soapy water should be removed after cleaning, do not allow soapy water to remain on the surface, and dry the cover with a clean, dry cotton cloth.

Use a soft cloth (non-woven fabric) dipped in a small amount of 75% concentration of medical alcohol to wipe the surface of the scanner handpiece. After a certain period of time, air dry it naturally or use another clean and dry soft cloth (non-woven fabric) to dry the residual alcohol. It is recommended to clean and disinfect once a day.

Note: Do not wipe with cleaning materials that will damage the surface of the covers, and do not allow liquids to enter the inside of the device and cause mechanical damage, and please pay special attention to the parts as shown in the figure.

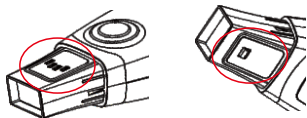

### 2.2. Cleaning and disinfection of the front protection window of the scanner body

Use a dust-free cotton swab dipped in a small amount of 75% concentration of medical alcohol to gently wipe the surface of the protective window to remove dirt, oil stains, spots and other traces on the lens. Use another clean, dry lint-free swab to dry the protective window surface.

CAUTION: The protective window is a delicate optical component and must be cleaned and disinfected with extreme care, and care must be taken not to allow excess liquid to flow into other locations when wiping.

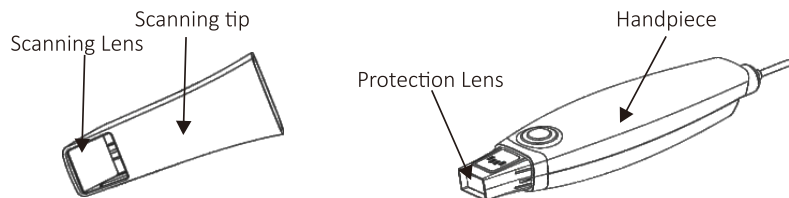

## ◆ Q&A

A. After pressing the power button, the device cannot be turned on.

1. Check the adapter connection.
2. If the power indicator is on, check whether the computer can identify the scanner driver.
3. Check the cable connection between the base & computer.
4. Check the cable connection between scanner handle & the base.

B. The computer has identified the device, but the scanning software can not start scanning.

1. Restart the software and reconnect with the device.
2. Turn off the device power and restart the device.

C. During the use of the device, scanning stops and can not continue working.

1. The device has the thermal protection function.  
Solution is : turn off the device, and keep off for 5 to 10 minutes according to different environment temperature, and then turn on again to see.
2. There is foggy issue on the scanning window.  
Solution is: remove the fog directly or put back the handpiece to the base support for external heating to remove the fog, then you can start scanning again.
3. The device water proof level is IPX0, so please don't directly spray water onto the device, or get the device immersed in various liquids.

D. During the use of the device, the scanning image slows down or suspends.

1. Check the USB cable connection see if it is good.
2. Check Whether the device is used for a long time leads to higher internal temperature.
3. If the above issues occur frequently, it may be that the usb internal data cable is broken. Please contact the local after-sales service staff.

E. During the use of the device, has large noise or the image color is distorted.

1. This device belongs to the precision instrument, should be handpiced gently. Heavier shocks may cause unpredictable damage to internal hardware.
2. Do Internal software calibration of the device.

### ◆ Product application precautions

1. The product is a precision optical device, which requires careful operation and maintenance; accidental collision or drop may cause damage or deviation of the optical components, and ultimately affect the scanning results. If the above situation occurs, please contact customer service staff in time.
2. When using and maintaining the Intraoral Scanner, it is necessary to protect the exposed optical components, such as the mirror of scanner tip mirror, protection glass on the end of the scanning head, etc. to avoid corrosive liquid erosion or sharp objects scratching the lens surface. If any of the above occurs, please contact customer service staff in time.
3. When scanning tip sterilization, it is necessary to avoid the infiltration of liquid from the back end of the scanning head. If there is infiltration and contamination of the inner surface of the lens, it is necessary to clean and blow dry with pure (99.9%) alcohol.
4. Please pay attention to the connections when using the Intraoral Scanner. The extra force is easy to make the connection unstable or even disconnected. Please also be careful not to bend the wire excessively to avoid damage.
5. When the scanner is not used, please remove the scanning head and cover the protective sleeve and turn off the base power. When not in use for a long time, pull out the power adapter.

### ◆ Circuit connection chart

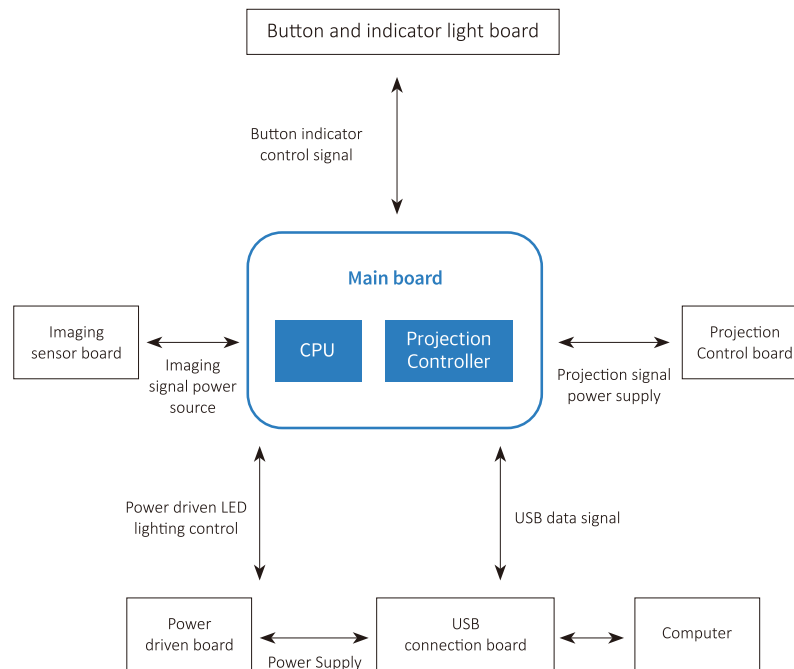

### ◆ Technical specification

- Cmos: 13 x 13mm
- Pixel Size: 1024 X 768 pixels
- Scope of reconstruction: 14 x 14 x 15 mm
- Intensity of light radiation: ≤ 100mW/cm<sup>2</sup>
- Size of scanner (scanning tip excluded): 200 x 58 x 36mm
- Data cable of scanner (connection between base and handpiece): 1.9m
- Usb data cable (base and computer connection): 1.2m
- Usb Connection: USB2.0

### PC Specification Suggestions:

#### Basic PC Specification Requirements:

- OS: Microsoft Windows 10/11, 1064 Pro or above;
- CPU: Intel i7-9700 quad-core or above ( Laptop requires i7-9700H or above);
- Graphics Card & Video Memory: NVIDIA GeForce 1660 GTX or above, more than 6G;
- Memory: 16G or above;
- Disk: 1 TB SSD or above.

### Equipment operating environment:

- Environment temperature: 10 °C-40°C
- Relative humidity: ≤ 85%;
- Atmospheric pressure: 86KPa~106KPa;

### Equipment storage, transportation environment:

- Environment temperature: -20°C-55°C
- Relative humidity: 10%~93%;
- Atmospheric pressure: 86KPa~106KPa;

### Power Adaptor

- Input: 100-240V~ 50-60Hz 0.7A
- Output: 12V --- 1.5A
- Intraoral scanner: 12V --- 1.5A

### ◆ Waste disposal

In order to reduce the burden on the environment, recyclable parts should be sent to the recycling center after removing the hazardous materials. Disposing of obsolete products is the responsibility of the recycler.

All components and elements containing hazardous substances shall be disposed of in accordance with law and environmental provisions. When dealing with waste products, they must be protected from harm.

△Recyclable

▲Unrecyclable

Part	Main material	Recyclable material	Disposal center	Separation of harmful substances
Cover	ABS	△		
Metal	Aluminum	△		△
Circuit board		▲		
Wire	Copper	△		
Packing	Paper	△		
Other			△	

### ◆ Electromagnetic compatibility

For this equipment, special precautions shall be taken for electromagnetic compatibility (EMC) and shall be installed and used in accordance with the EMC information specified in this manual. Portable and mobile radio frequency communications equipment may have an impact on the equipment.

Except as internal components of the spare parts for sale cable (transducer), using the specified attachment and cable (transducer) may lead to increase of equipment or system launch or immunity to reduce equipment or system should not be put to use with other devices or close to, if use must be close to or stacked, validation should be observed in the use of a coffret under normal operation.

The following cables must be used to meet the requirements of electromagnetic emission and anti-interference:

Name of cable	Length
Power Cable	1. 9m
Cable (connection between base and scanner)	1. 9m
Cable (connection between scanner and computer)	1. 2m

The fundamental nature can be used for image acquisition.

Name	Description
Image acquisition	When you turn on the power, start the software and move the handle, the image display box on the software can display the image normally.

### Accessories

Guidance and manufacture's declaration- electromagnetic emissions		
The Intraoral Scanner is intended for use in the electromagnetic environment specified below. The customer or the user of the Intraoral Scanner should assure that it is used in such an electromagnetic environment:		
Emission Test	Compliance	Electromagnetic environment- guide
RF emission CISPR 11	Group 1	The Intraoral Scanner uses RF energy only for its internal function. Therefore, its RF emissions are very low and are not likely to cause any interference in nearby electronic equipment.
RF emission CISPR 11	Class B	The Intraoral Scanner is suitable for use in all establishments, including domestic establishments and those directly connected to the public low-voltage power supply network that supplies buildings used for domestic purposes.
Harmonic emission IEC 61000-3-2	Class A	
Voltage fluctuations / flicker emission IEC 61000-3-3	Applied	



Guidance & Manufacturer's Declaration-Electromagnetic Immunity			
The Intraoral Scanner is intended for use in the electromagnetic environment specified below. The customer or the user of the Intraoral Scanner should assure that it is used in such an electromagnetic environment:			
Immunity Test	IEC60601 Test Level	Compliance level	Electromagnetic Environment-Guidance
Electrostatic discharge (ESD) IEC 61000-4-2	±6 kV contact ±8 kV air	±6 kV contact ±8 kV air	Floors should be wood, concrete or ceramic tile. If floors are covered with synthetic material, the relative humidity should be at least 30%.
Electrical fast transient/burst IEC 61000-4-4	±2 kV for power supply lines ±1 kV for input/output lines	±2 kV for power supply lines	Mains power quality should be that of a typical commercial or hospital environment.
Surge IEC 61000-4-5	±1 kV Differential mode ±2 kV common mode	±1 kV Differential mode ±2 kV common mode	Mains power quality should be that of a typical commercial or hospital environment.
Voltage dips, short interruption and voltage variations on power supply input lines IEC 61000-4-11	<5 % UT (>95% dip in UT) for 0.5 cycle 40 % UT (60% dip in UT) for 5 cycles 70 % UT (30% dip in UT) for 25 cycles <5 % UT (95% dip in UT) for 5 sec	<5 % UT (>95% dip in UT) for 0.5 cycle 40 % UT (60% dip in UT) for 5 cycles 70 % UT (30% dip in UT) for 25 cycles <5 % UT (95% dip in UT) for 5 sec	Mains power quality should be that of a typical commercial or hospital environment. If the user of the Intraoral Scanner requires continued operation during power mans interruption, it is recommended that the Intraoral Scanner be powered from an uninterruptible power supply or a battery.
Power frequency (50/60 Hz) magnetic field IEC 61000-4-8	3A/m	3A/m	Power frequency magnetic fields should be at levels characteristic of a typical location in a typical commercial or hospital environment.

Note: UT is the a.c. mains voltage prior to application of the test level.

Guidance & Manufacturer's Declaration-Electromagnetic Immunity			
The Intraoral Scanner is intended for use in the electromagnetic environment specified below. The customer or the user of the Intraoral Scanner should assure that it is used in such an electromagnetic environment:			
Immunity test	IEC 60601 The test level	Compliance level	Electromagnetic environment - guide
Conducted RF IEC 61000-4-6 Radiated RF IEC 61000-4-3	3 Vrms 150 kHz to 80 MHz 3 V/m 80 MHz to 2.5 GHz	3 Vrms 3 V/m	Portable and mobile RF communications equipment should be used no closer to any part of the Intraoral Scanner, including cables, than the recommended separation distance calculated from the equation applicable to the frequency of the transmitter. Recommended separation distance $d = 1.2\sqrt{P}$ $d = 1.2\sqrt{P}$ 80 MHz to 800 MHz $d = 23\sqrt{P}$ 800 MHz to 2.5 GHz  where P is the maximum output power rating of the transmitter in watts(W) according to the transmitter manufacturer and d is the recommended separation distance in meters(m). Field strengths from fixed RF transmitters, as determined by an electromagnetic site survey a, should be less than the compliance level in each frequency range.b Interference may occur in the vicinity of equipment marked with the following symbol: 

Note 1: At 80 MHz and 800 MHz, the higher frequency range applies.

Note 2: These guidelines may not apply in all situations. Electromagnetic propagation is affected by absorption and reflection from structures, objects and people.

Field strengths from fixed transmitters, such as base stations for radio (cellular/cordless) telephones and land mobile radios, amateur radio, AM and FM radio broadcast and TV broadcast cannot be predicted theoretically with accuracy. To assess the electromagnetic environment due to fixed RF transmitter transmitters, an electromagnetic site survey should be considered. If the measured field strength in the location in which the Intraoral Scanner is used exceeds the applicable RF compliance level above, the Intraoral Scanner should be observed to verify normal operation. If abnormal performance observed, additional measures may be necessary, such as reorienting or relocating the Intraoral Scanner.

Recommended separation distances between portable and mobile RF communications equipment and the Intraoral Scanner

The Intraoral Scanner is intended for use in an electromagnetic environment in which radiated RF disturbances are controlled. The customer or the user of the Intraoral Scanner can help prevent electromagnetic interference by maintaining a minimum distance between portable and mobile RF communications equipment (transmitters) and the Intraoral Scanner as recommended below, according to the maximum output power of the communications equipment.

Rated maximum output power of transmitter /W	Separation distance according to frequency of transmitter /m		
	150 kHz ~ 80 MHz $d = 1.2\sqrt{P}$	80 MHz ~ 800 MHz $d = 1.2\sqrt{P}$	800 MHz ~ 2.5 GHz $d = 2.3\sqrt{P}$
0.01	0.12	0.12	0.23
0.1	0.38	0.38	0.73
1	1.2	1.2	2.3
10	3.8	3.8	7.3
100	12	12	23

For transmitters rated at a maximum output power not listed above, the recommended separation distance  $d$  meters(m) can be estimated using the equation applicable to the frequency of the transmitter, where  $P$  is the maximum output power rating of the transmitter in watts(W) according to the transmitter manufacturer.

- Note 1:** At 80 MHz and 800 MHz, the separation distance for the higher frequency range applies.
- Note 2:** These guidelines may not apply in all situations. Electromagnetic propagation is affected by absorption and reflection from structures, objects and people.